

CONDUCTIVELY COOLED LASER DIODE ARRAY

S25

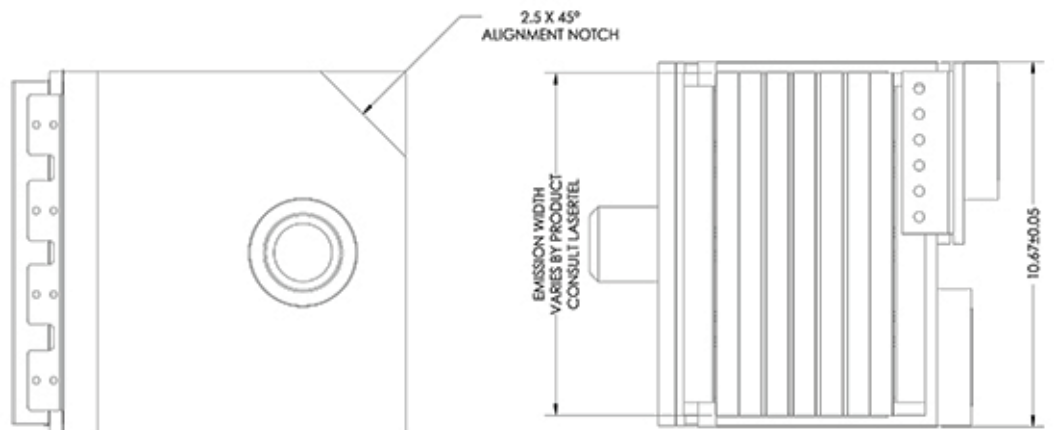
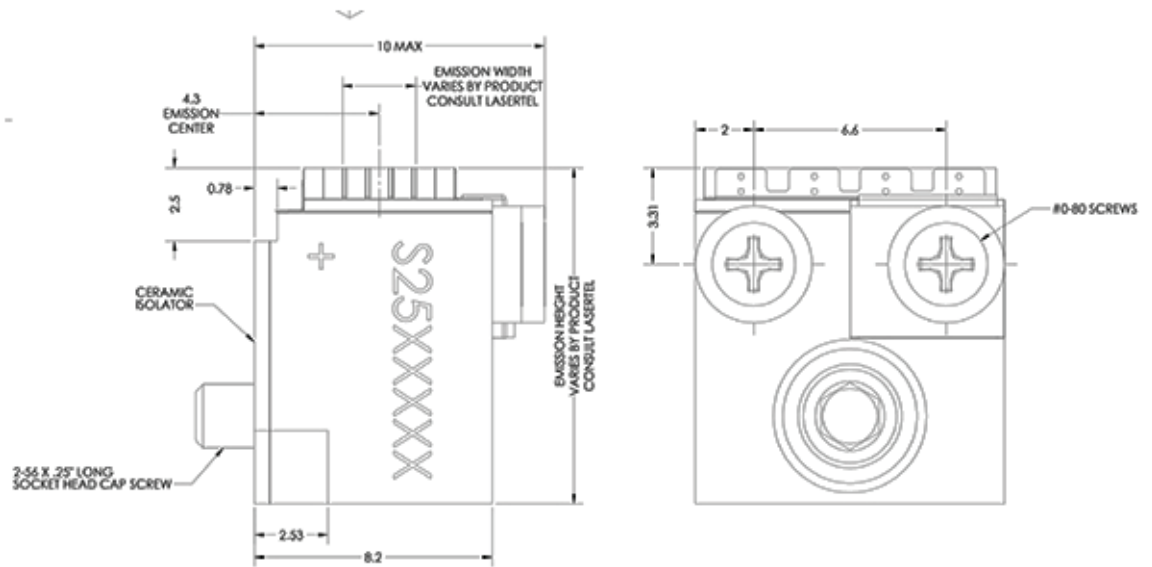
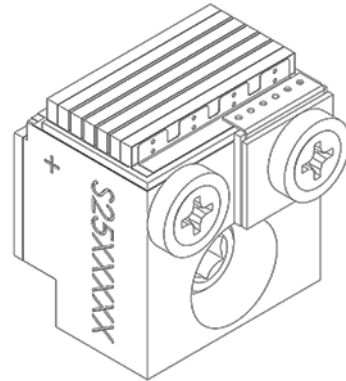

Lasertel products proudly made in the USA
P: +1 877.844.1444 E: SALES@LASERTEL.COM

TYPICAL SPECIFICATIONS

760nm - 1100nm

TYPICAL OPTICAL PARAMETERS (@25 °C)	Units	Typical Value					
Array Peak Output Power	W	2000	4000	6000	10000	2000	3000
Bar Emission Length	mm	10				3	5
Operation Mode		Pulsed					
Operating Current	A	95	200	330	550	120	165
Number of Bars	#	up to 20					
Operating Voltage per Bar (760nm - 830nm)	V	1.9		2	2.1	2	
Operating Voltage per Bar (850nm - 1100nm)	V	1.5		1.6	1.7	1.6	
Power Conversion Efficiency	%	60		58			
Bar to Bar Pitch	mm	0.35, 0.40, 1.2					
Beam Divergence							
Fast Axis (FWHM)	°	36			32	36	
Slow Axis (FWHM)	°	10					

1400nm - 1700nm

TYPICAL OPTICAL PARAMETERS (@25 °C)	Units	Typical Value
Array Peak Output Power	W	500
Bar Emission Length	mm	10
Operation Mode		Pulsed
Operating Current	A	95
Number of Bars	#	up to 20
Operating Voltage per Bar	V	1.5
Power Conversion Efficiency	%	25
Bar to Bar Pitch	mm	0.35, 0.40, 1.2
Beam Divergence		
Fast Axis (FWHM)	°	27
Slow Axis (FWHM)	°	10

Patent Numbers: US 7,660,335 | US 7,864,825 | US 6,352,873 | US 6,295,307



Lasertel products proudly made in the USA
P: +1 877.844.1444 E: SALES@LASERTEL.COM